

Article number: 604145056055

Description: Timing belt pulley with hub
HTD 56 14M 55

Measures

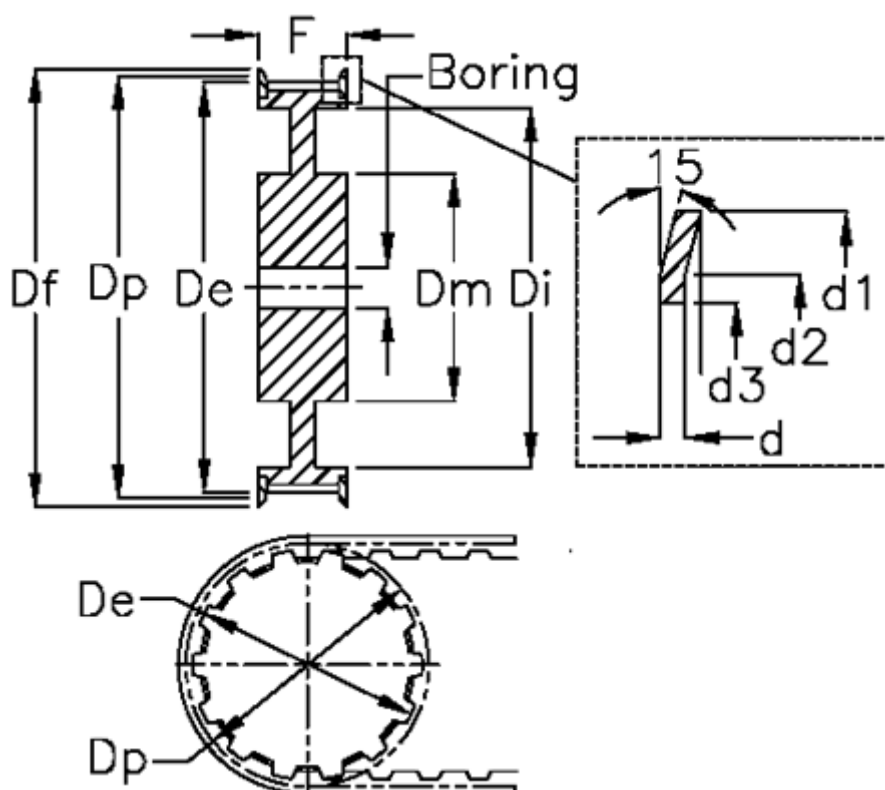

Bore = 28	Dm = 135	Width = 55
d = 2.5	Dp = 249.55	
d1 = 256	F = 207	
d2 = 240	Flange type = F66	
d3 = 220	L = 70	
De = 246.76	Tooth number = 56	
Df = 256	Type = 14M	
Di = 70	Weight = 14.5	